

MINI-MAX

WI-FI INSTALLATION

OVERVIEW

Maximum has designed a system that captures all its exterior sensor options and transmits the weather conditions through your home or business wi-fi network. You can use this signal to display on our beautiful weather instruments and or interface with the Weather Underground website to monitor your installation remotely. If you would like to monitor your station on Weather Underground visit their website www.wunderground.com and join. Follow the screen prompts to obtain a station id and password that will be required during the Captive Portal setup.

PROPER INSTALLATION IS IMPORTANT. IF YOU NEED ASSISTANCE, CONSULT A CONTRACTOR, ELECTRICIAN OR TELEVISION ANTENNA INSTALLER (CHECK WITH LOCAL BUILDING SUPPLY, OR HARDWARE STORE FOR REFERRALS). **TO PROMOTE CONFIDENCE, PERFORM A TRIAL WIRING (BENCH TEST) BEFORE INSTALLATION.**

BENCH TEST

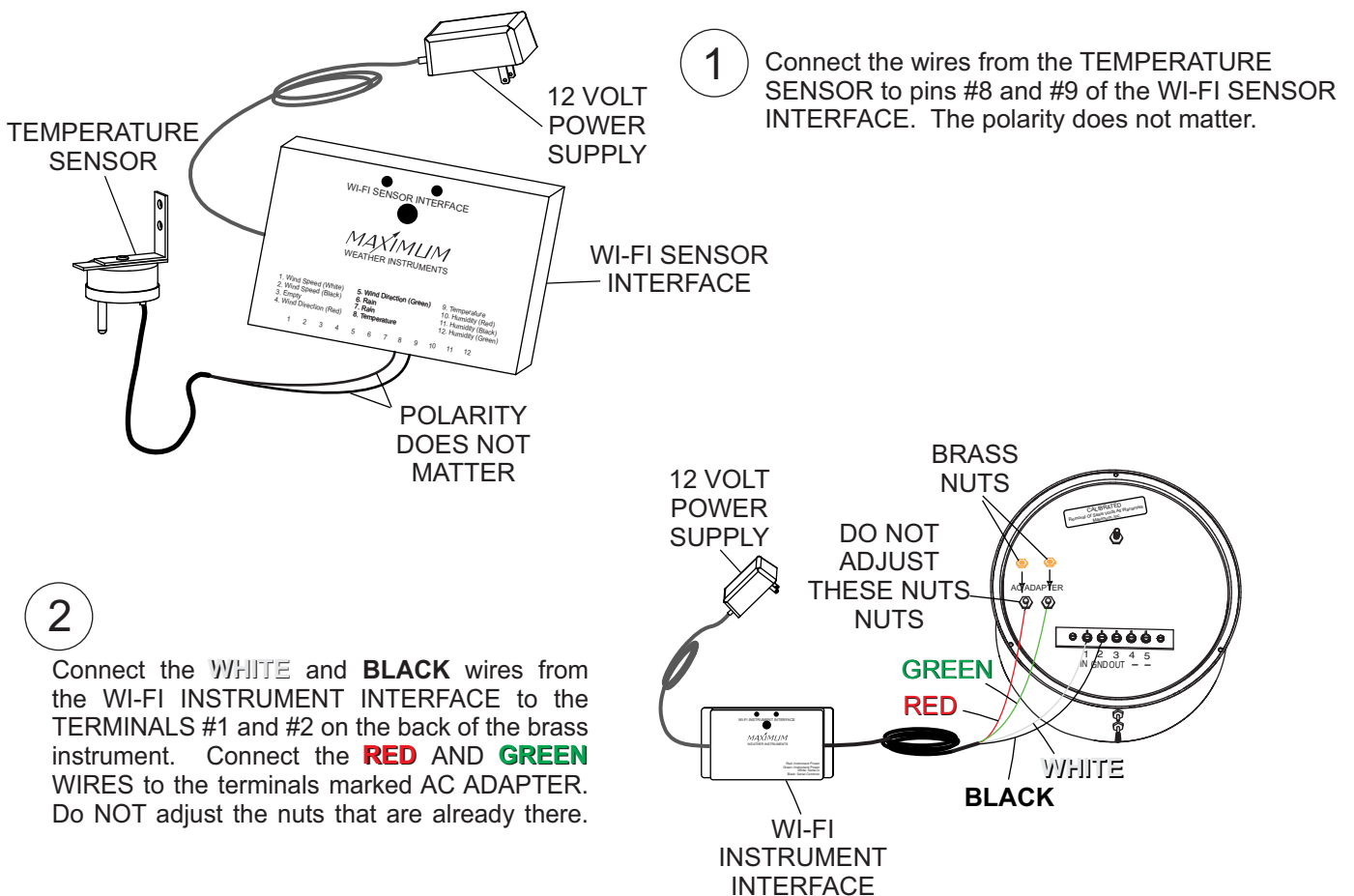

MAXIMUM INC

30 Barnet Boulevard
New Bedford, MA 02745
(508) 995-2200

MINI-MAX

WI-FI

INSTALLATION

BENCH TEST (CONTINUED)

- 3 Plug in both power supplies and you should see the boot sequence indicated on the INTERFACE.

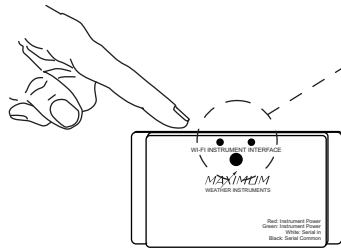

BENCH TEST BOOT SEQUENCE

Step	Sys	App	Description
1	●	●	Power Applied
	WI-FI INSTRUMENT INTERFACE	WI-FI INSTRUMENT INTERFACE	
1	●	●	System Started
	WI-FI INSTRUMENT INTERFACE	WI-FI INSTRUMENT INTERFACE	
1	●	●	Captive Portal Launched
	WI-FI INSTRUMENT INTERFACE	WI-FI INSTRUMENT INTERFACE	
1	●	●	Captive Portal Running
	WI-FI INSTRUMENT INTERFACE	WI-FI INSTRUMENT INTERFACE	

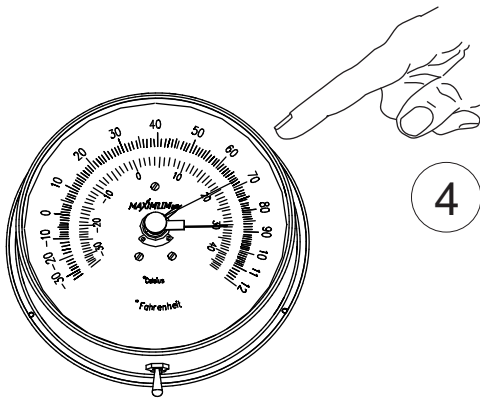

- 4 The BRASS DIAL should indicate the current temperature at the location of the TEMPERATURE SENSOR. If not then check the wiring for correct connections.

Unplug both 12 volt power supplies and remove the wiring and cables and proceed with a permanent installation.

MAXIMUM INC

30 Barnet Boulevard
New Bedford, MA 02745
(508) 995-2200

MINI-MAX

WI-FI

INSTALLATION

- 1 Mount the temperature sensor assembly with the two the two large wood screws. Select a location that is protected from direct sunlight and sheltered from the rain and snow.

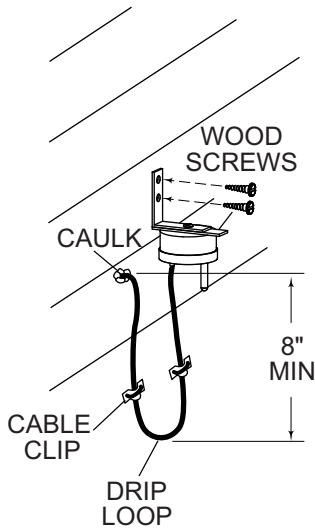

- 2 If the WI-FI SENSOR INTERFACE is to be inside and the SENSOR itself outside, form a drip loop at least eight inches below the SENSOR and at least eight inches below the point of entry into the building. Anchor any exposed wire with insulated cable clips. Run the wire into the building to the location where the SENSOR INTERFACE will be located. Caulk any holes when done.

- 3 Connect the wires from the TEMPERATURE SENSOR to pins #8 and #9 of the WI-FI SENSOR INTERFACE.

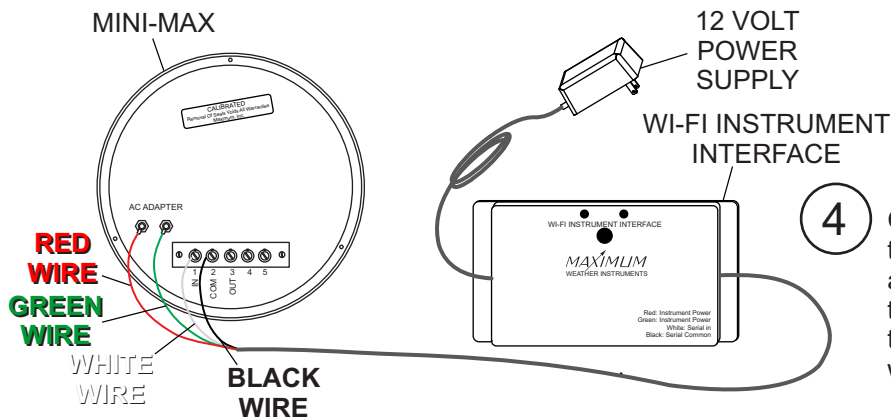
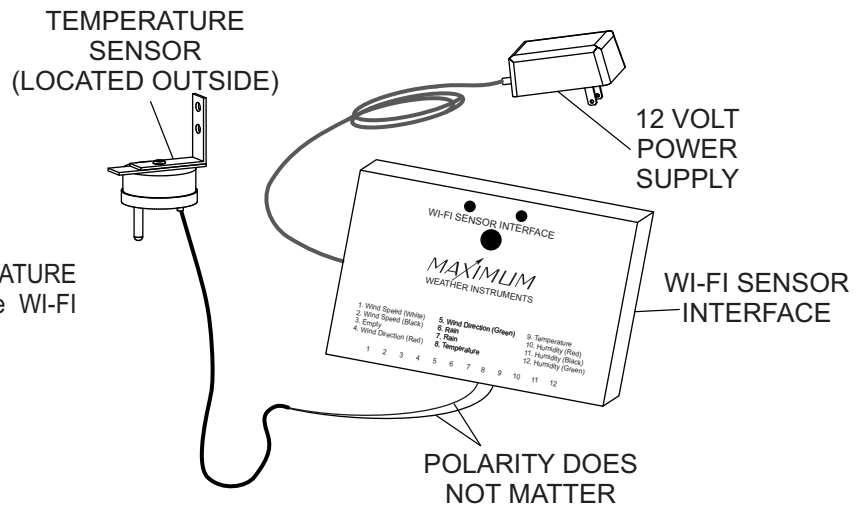

- 4 Connect the red and green wires to the terminals labeled AC ADAPTER as shown in the illustration. Connect the **WHITE** wire to the number 1 terminal and connect the **BLACK** wire to the number 2 terminal.

MAXIMUM INC

30 Barnet Boulevard
New Bedford, MA 02745
(508) 995-2200

MINI-MAX

WI-FI

OPTIONAL INSTALLATION WITH RAINWATCH AND MAESTRO

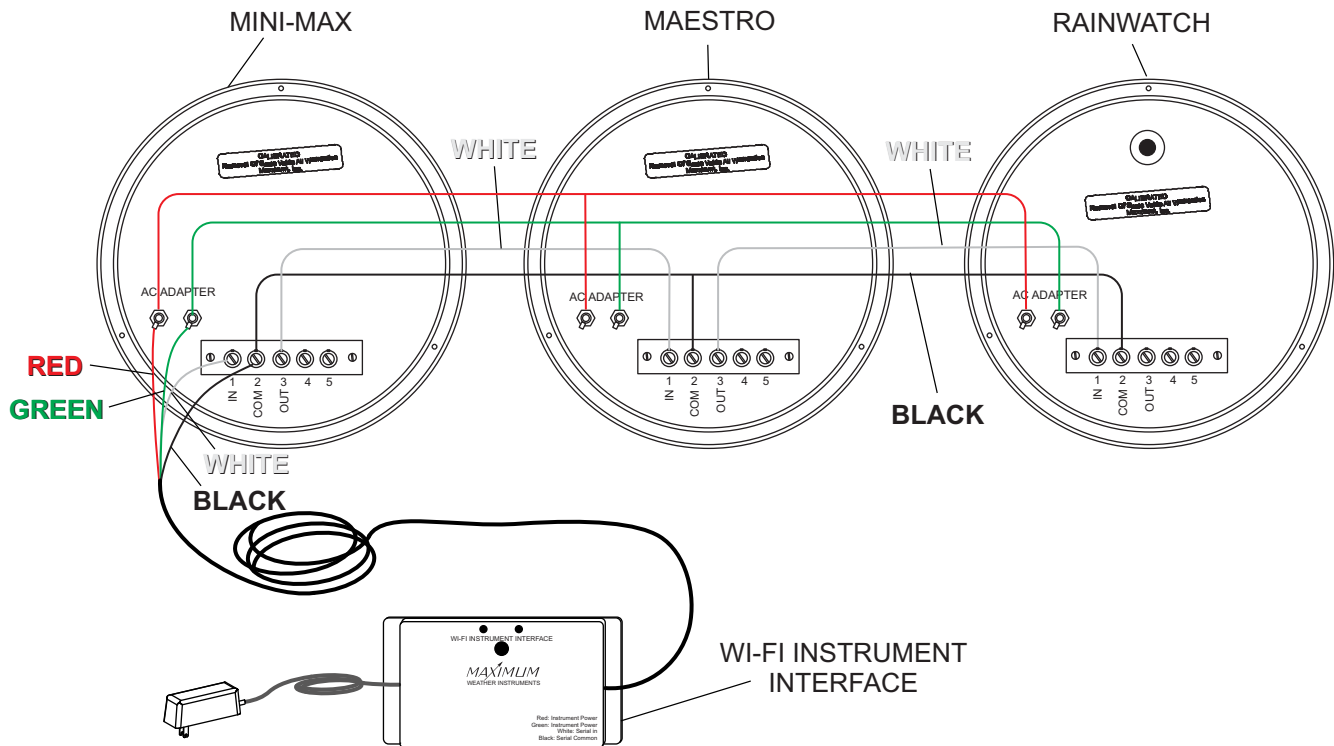

RAINWATCH WITH MINI-MAX AND MAESTRO CONNECTIONS

- 1 Connect the **RED** and **GREEN** wires from the INTERFACE to the power terminals on the back of the MINI-MAX. The polarity does not matter. Connect other instruments from the power terminals on the back of the MINI-MAX.
- 2 Connect the **WHITE** wire from the INSTRUMENT INTERFACE to TERMINAL #1 (IN) of the MINI-MAX.
- 3 Connect the **BLACK** wire from the INSTRUMENT INTERFACE to TERMINAL #2 (COM) of the MINI-MAX.
- 4 A. Connect the **WHITE** wire from MINI-MAX TERMINAL #3 (OUT) to MAESTRO TERMINAL #1 (IN).
B. Connect the **BLACK** wire from MINI-MAX TERMINAL #2 (COM) to MAESTRO TERMINAL #2 (COM).
- 5 A. Connect the **WHITE** wire from MAESTRO TERMINAL #3 (OUT) to RAINWATCH TERMINAL #1 (IN).
B. Connect the **BLACK** wire from RAINWATCH TERMINAL #2 (COM) to MAESTRO TERMINAL #2 (COM).
- 6 The order of the instruments does not matter i.e. the WI-FI could just as well be wired into the RAINWATCH and the MINI-MAX and MAESTRO could be from the RAINWATCH

MAXIMUM INC.

30 Barnet Boulevard
New Bedford, MA 02745
(508) 995-2200

MINI-MAX

WI-FI

OPERATION

Your Mini-Max II has two switches. The toggle switch is for selecting the function. The small push button switch behind the toggle is for resetting the memories.

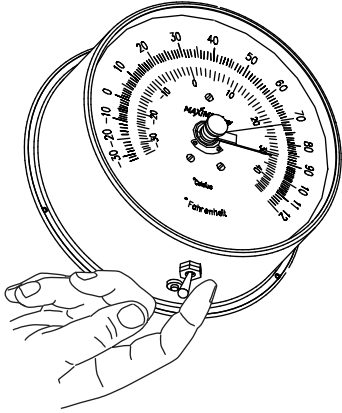

- 1 Lightly holding the toggle switch to the left will display the recorded low temperature since the last reset.

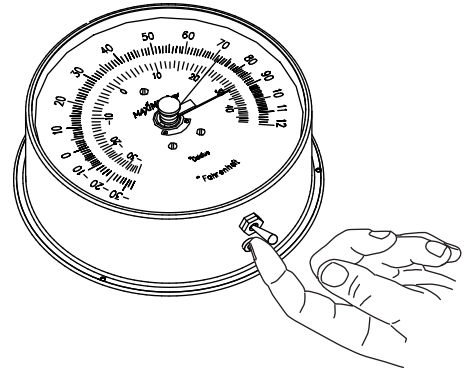

- 2 Lightly holding the toggle switch to the right will display the recorded high temperature since the last reset.

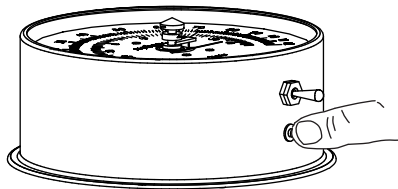

- 3 Fully depressing the small push button switch for five seconds resets both memories. The instrument will now display current temperature and the memories once again begin storing the new high and low temperatures.

(After resetting wait 10 seconds before activating the toggle switch.)

NOTE: Before reading your thermometer, you should lightly tap the case with your finger. A TAP change of 1-2 degrees is a common occurrence with any slow moving

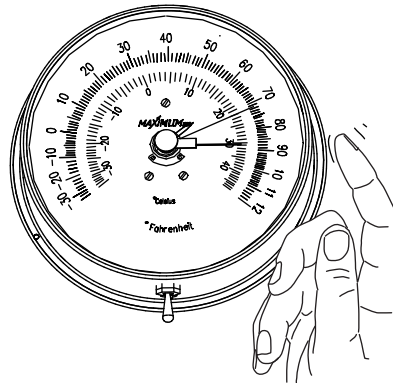

- 4

The trend register needle can be set by turning the center knob on the indicator dial.

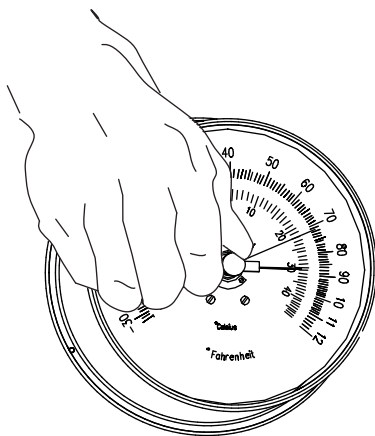

MAXIMUM INC

30 Barnet Boulevard
New Bedford, MA 02745
(508) 995-2200